

HIGH VOLTAGE FASTSWITCHING NPN POWER TRANSISTOR

- SGS-THOMSON PREFERRED SALESTYPE
- HIGH VOLTAGE CAPABILITY
- U.L. RECOGNISED ISOWATT218 PACKAGE (U.L. FILE # E81734 (N))

APPLICATIONS:

- HORIZONTAL DEFLECTION FOR COLOUR TVS AND MONITORS
- SWITCH MODE POWER SUPPLIES

DESCRIPTION

The BUH713 is manufactured using Multi-epitaxial Mesa technology for cost-effective high performance and uses a Hollow Emitter structure to enhance switching speeds. .

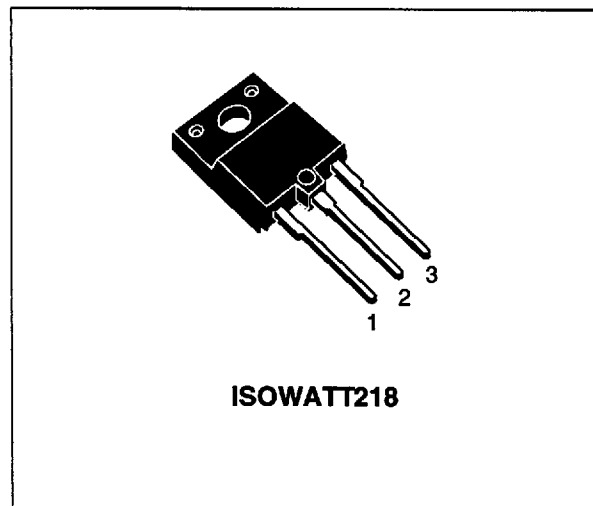
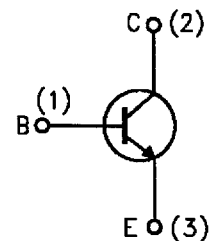
INTERNAL SCHEMATIC DIAGRAM

ABSOLUTE MAXIMUM RATINGS

Symbol	Parameter	Value	Unit
V _{CBO}	Collector-Base Voltage (I _E = 0)	1300	V
V _{CEO}	Collector-Emitter Voltage (I _B = 0)	700	V
V _{EBO}	Emitter-Base Voltage (I _C = 0)	10	V
I _C	Collector Current	10	A
I _{CM}	Collector Peak Current (t _p < 5 ms)	20	A
I _B	Base Current	5	A
I _{BM}	Base Peak Current (t _p < 5 ms)	10	A
P _{tot}	Total Dissipation at T _c = 25 °C	57	W
T _{stg}	Storage Temperature	-65 to 150	°C
T _j	Max. Operating Junction Temperature	150	°C

THERMAL DATA

$R_{thj-case}$	Thermal Resistance Junction-case	Max	2.2	$^{\circ}C/W$
----------------	----------------------------------	-----	-----	---------------

ELECTRICAL CHARACTERISTICS ($T_{case} = 25^{\circ}C$ unless otherwise specified)

Symbol	Parameter	Test Conditions	Min.	Typ.	Max.	Unit
I_{CES}	Collector Cut-off Current ($V_{BE} = 0$)	$V_{CE} = 1300 V$			1	mA
		$V_{CE} = 1300 V \quad T_j = 125^{\circ}C$			2	mA
I_{EBO}	Emitter Cut-off Current ($I_C = 0$)	$V_{EB} = 5 V$			100	μA
$V_{CEO(sus)}$	Collector-Emitter Sustaining Voltage	$I_C = 100 mA$	700			V
V_{EBO}	Emitter-Base Voltage ($I_C = 0$)	$I_E = 10 mA$	10			V
$V_{CE(sat)*}$	Collector-Emitter Saturation Voltage	$I_C = 7 A \quad I_B = 1.5 A$			1.5	V
$V_{BE(sat)*}$	Base-Emitter Saturation Voltage	$I_C = 7 A \quad I_B = 1.5 A$			1.3	V
h_{FE*}	DC Current Gain	$I_C = 7 A \quad V_{CE} = 5 V$	8			
		$I_C = 7 A \quad V_{CE} = 5 V \quad T_j = 100^{\circ}C$	5			
t_s t_f	RESISTIVE LOAD Storage Time Fall Time	$V_{CC} = 400 V \quad I_C = 7 A$ $I_{B1} = 1.5 A \quad I_{B2} = 3.5 A$		2.1 140	3.1 210	μs ns
		$I_C = 7 A \quad f = 15625 Hz$ $I_{B1} = 1.5 A \quad I_{B2} = -3.5 A$ $V_{ceflyback} = 1050 \sin\left(\frac{\pi}{10} 10^6\right) t \quad V$		3.5 350		μs ns
t_s t_f	INDUCTIVE LOAD Storage Time Fall Time	$I_C = 7 A \quad f = 31250 Hz$ $I_{B1} = 1.5 A \quad I_{B2} = -3.5 A$ $V_{ceflyback} = 1200 \sin\left(\frac{\pi}{5} 10^6\right) t \quad V$		3.5 320		μs ns

* Pulsed: Pulse duration = 300 μs , duty cycle 1.5 %

Safe Operating Area

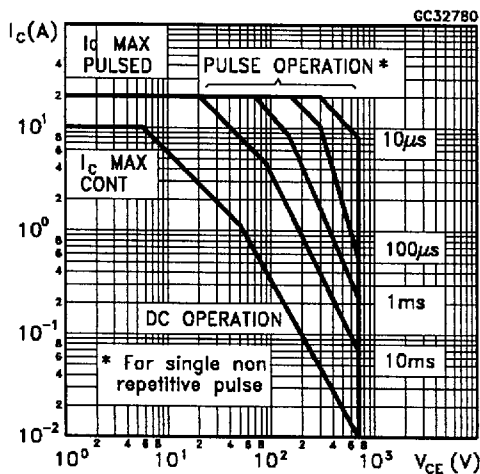

Thermal Impedance

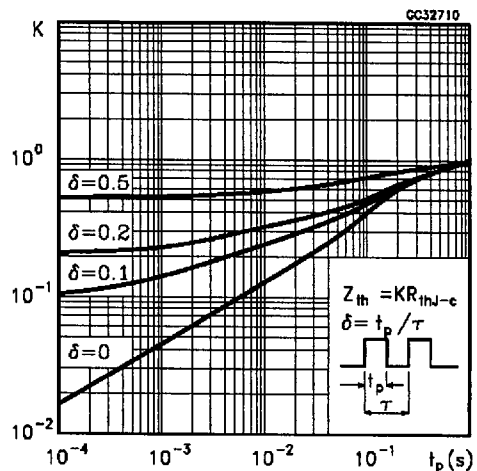

Derating Curve

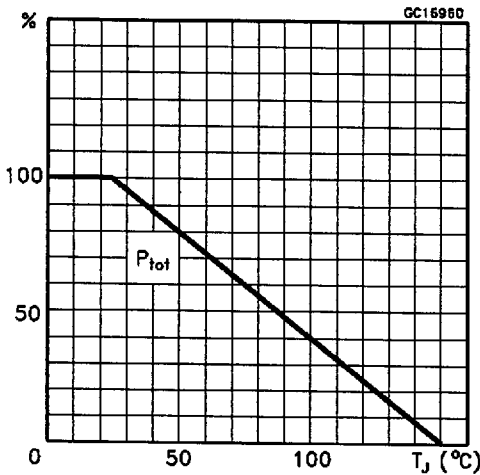

DC Current Gain

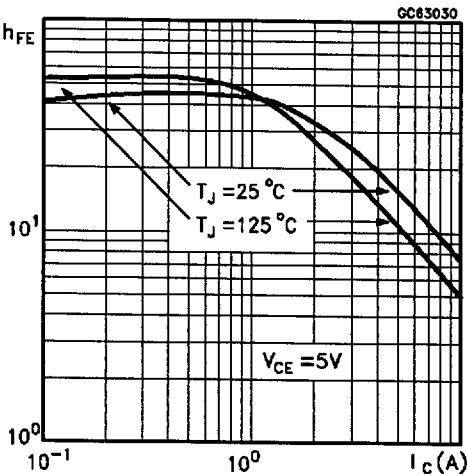

Collector Emitter Saturation Voltage

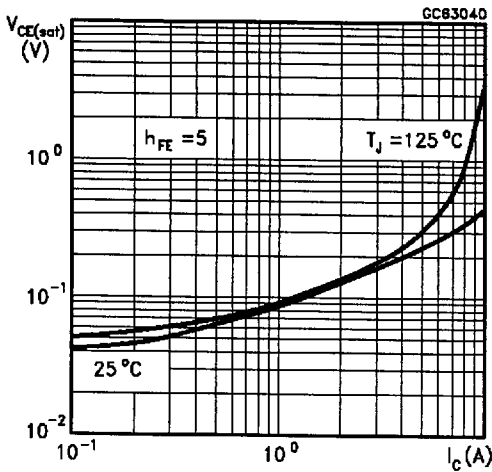

Base Emitter Saturation Voltage

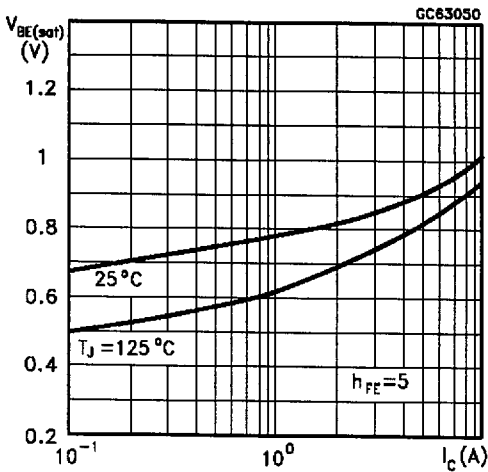

Power Losses at 16 KHz

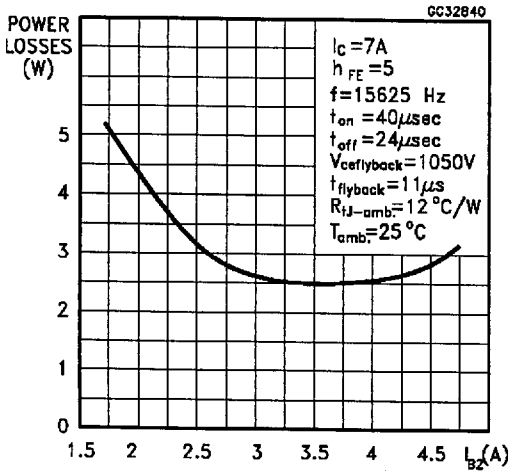

Switching Time Inductive Load at 16KHz (see figure 2)

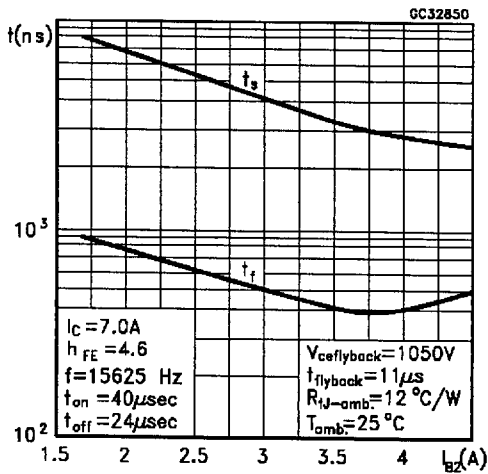

Power Losses at 32 KHz

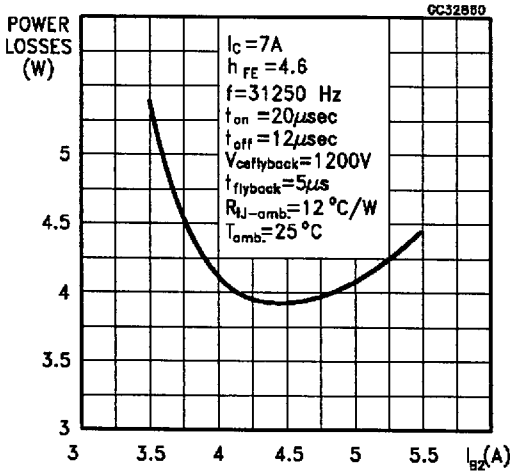

Switching Time Inductive Load at 32 KHz
(see figure 2)

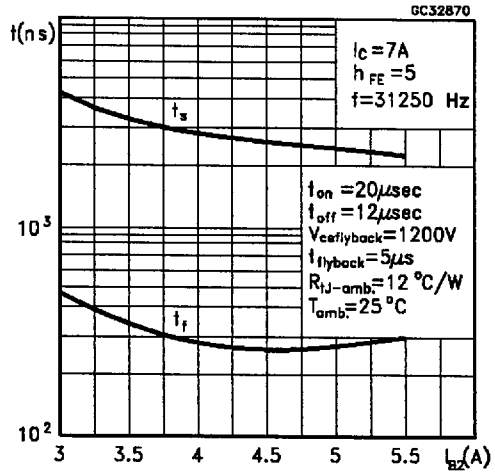

Reverse Biased SOA

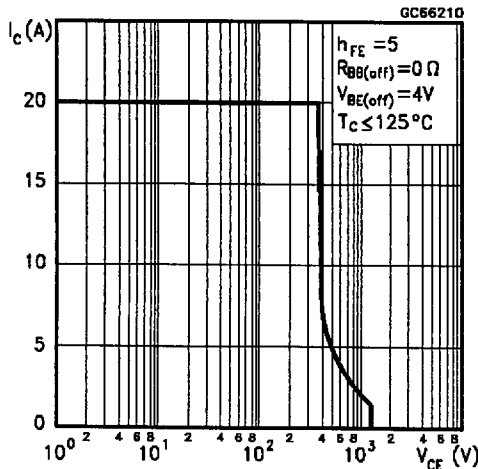

BASE DRIVE INFORMATION

In order to saturate the power switch and reduce conduction losses, adequate direct base current I_{B1} has to be provided for the lowest gain h_{FE} at 100 °C (line scan phase). On the other hand, negative base current I_{B2} must be provided to turn off the power transistor (retrace phase).

Most of the dissipation, in the deflection application, occurs at switch-off. Therefore it is essential to determine the value of I_{B2} which minimizes power losses, fall time t_f and, consequently, T_j . A new set of curves have been defined to give total power losses, t_s and t_f as a function of I_{B2} at both 16 KHz, 32 KHz and 64KHz scanning frequencies for choosing the optimum negative drive. The test circuit is

illustrated in figure 1.

Inductance L_1 serves to control the slope of the negative base current I_{B2} to recombine the excess carrier in the collector when base current is still present, this would avoid any tailing phenomenon in the collector current.

The values of L and C are calculated from the following equations:

$$\frac{1}{2} L (I_C)^2 = \frac{1}{2} C (V_{CE(fly)})^2 \quad \omega = 2 \pi f = \frac{1}{\sqrt{LC}}$$

Where I_C = operating collector current, $V_{CE(fly)}$ = flyback voltage, f = frequency of oscillation during retrace.

Figure 1: Inductive Load Switching Test Circuits.

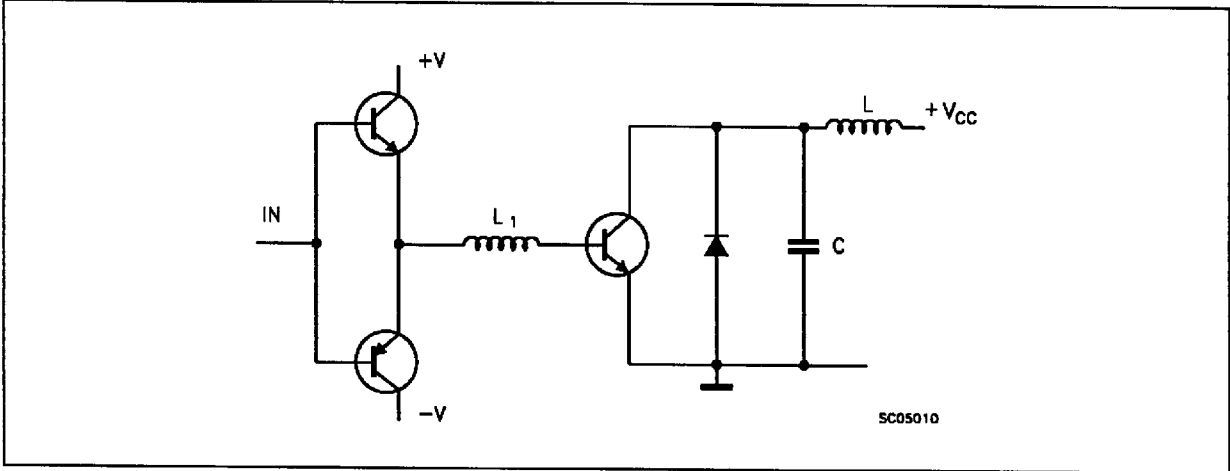
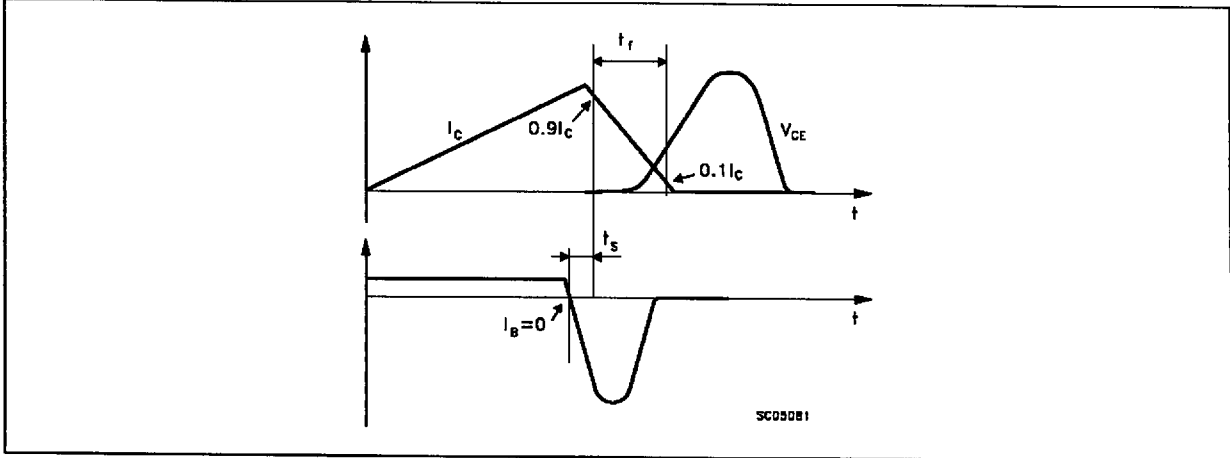

Figure 2: Switching Waveforms in a Deflection Circuit



ISOWATT218 MECHANICAL DATA

DIM.	mm			inch		
	MIN.	TYP.	MAX.	MIN.	TYP.	MAX.
A	5.35		5.65	0.210		0.222
C	3.3		3.8	0.130		0.149
D	2.9		3.1	0.114		0.122
D1	1.88		2.08	0.074		0.081
E	0.45		1	0.017		0.039
F	1.05		1.25	0.041		0.049
G	10.8		11.2	0.425		0.441
H	15.8		16.2	0.622		0.637
L1	20.8		21.2	0.818		0.834
L2	19.1		19.9	0.752		0.783
L3	22.8		23.6	0.897		0.929
L4	40.5		42.5	1.594		1.673
L5	4.85		5.25	0.190		0.206
L6	20.25		20.75	0.797		0.817
M	3.5		3.7	0.137		0.145
N	2.1		2.3	0.082		0.090
U		4.6			0.181	

